

Hitachi Koki

ORBITAL SANDER MODEL SV 12V · SV12SD SV 12SE INSTRUCTION MANUAL

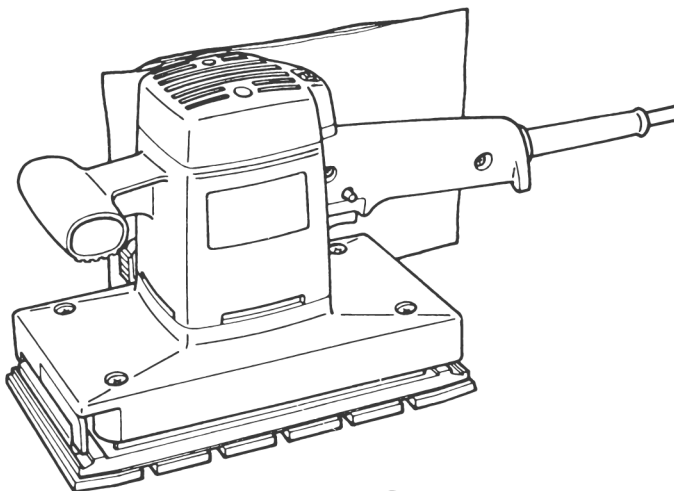

SV12V

Note:

Before using this Electric Power Tool, carefully read through this INSTRUCTION MANUAL to ensure efficient, safe operation. It is recommended that this MANUAL be kept readily available as an important reference when using this power tool.



DOUBLE INSULATION

HITACHI

We sincerely thank you for selecting a HITACHI ELECTRIC POWER TOOL. To operate this electric power tool safely and efficiently, please read this INSTRUCTION MANUAL carefully to get a good understanding of the precautions in operation, capacity of the electric power tool, use and the like.

IMPORTANT INFORMATION: SAFETY RULES FOR POWER TOOLS

WARNING: When using electric tools, basic safety precautions should always be followed to reduce the risk of fire, electric shock, and personal injury, including the following.

READ ALL INSTRUCTIONS

- 1. KEEP WORK AREA CLEAN.** Cluttered areas and benches invite injuries.
- 2. CONSIDER WORK AREA ENVIRONMENT.**
 - Don't expose power tools to rain.
 - Don't use power tools in damp or wet locations.
 - Keep work area well lit.
 - Don't use tool in presence of flammable liquids or gases.
 - Power tools produce sparks during operation. They also spark when switching ON/OFF. Never use power tools in dangerous sites containing lacquer, paint, benzene, thinner, gasoline, gases, adhesive agents, and other materials which are combustible or explosive.
- 3. GUARD AGAINST ELECTRIC SHOCK.** Prevent body contact with grounded surfaces. For example; pipes, radiators, ranges, refrigerator enclosures.
- 4. KEEP CHILDREN AWAY.** Do not let visitors contact tool or extension cord. All visitors should be kept away from work area.
- 5. STORE IDLE TOOLS.** When not in use, tools should be stored in dry, and high or locked-up place-out of reach of children.
- 6. DON'T FORCE TOOL.** It will do the job better and safer at the rate for which it was intended.
- 7. USE RIGHT TOOL.** Don't force small tool or attachment to do the job of a heavy-duty tool. Don't use tool for purpose not intended-for example-don't use circular saw for cutting tree limbs or logs.
- 8. DRESS PROPERLY.** Do not wear loose clothing or jewelry. They can be caught in moving parts.
 - Rubber gloves and non-skid footwear are recommended when working outdoors.
 - Wear protective hair covering to contain long hair.
- 9. USE SAFETY GLASSES.** Also use face or dust mask if cutting operation is dusty.
 - All persons in the area where power tools are being operated should also wear safety eye protectors and face or dust masks.
- 10. DON'T ABUSE CORD.** Never carry tool by cord or yank it to disconnect from receptacle. Keep cord from heat, oil and sharp edges.

11. **SECURE WORK.** Use clamps or a vise to hold work. It's safer than using your hand and it frees both hands to operate tool.
12. **DON'T OVERREACH.** Keep proper footing and balance at all times.
13. **MAINTAIN TOOLS WITH CARE.** Keep tools sharp and clean for better and safer performance.
Follow instructions for lubricating and changing accessories.
Inspect tool cords periodically and if damaged, have repaired by authorized service facility.
Inspect extension cords periodically and replace if damaged.
Keep handles dry, clean, and free from oil and grease.
14. **DISCONNECT TOOLS.** When not in use, before servicing, and when changing accessories, such as blades, bits, cutters.
15. **REMOVE ADJUSTING KEYS AND WRENCHES.** Form habit of checking to see that keys and adjusting wrenches are removed from tool before turning it on.
16. **AVOID UNINTENTIONAL STARTING.** Don't carry plugged-in tool with finger on switch. Be sure switch is off when plugging in.
17. **OUTDOOR USE EXTENSION CORDS.** When tool is used outdoors, use only extension cords intended for use outdoors and so marked.
18. **STAY ALERT.** Watch what you are doing. Use common sense. Do not operate tool when you are tired.
19. **CHECK DAMAGED PARTS.** Before further use of the tool, a guard or other part that is damaged should be carefully checked to determine that it will operate properly and perform its intended function. Check for alignment of moving parts, binding of moving parts, breakage of parts, mounting, and any other conditions that may affect its operation. A guard or other part that is damaged should be properly repaired or replaced by an authorized service center unless otherwise indicated elsewhere in this instruction manual.
Have defective switches replaced by authorized service center.
Do not use tool if switch does not turn it on and off.
20. **AVOID USING A POWER TOOL FOR APPLICATIONS OTHER THAN THOSE SPECIFIED.** Never use a power tool for applications other than those specified in the instruction manual.
21. **ENSURE SAFE OPERATION THROUGH CORRECT HANDLING.** Secure safe operation through correct handling by observing the instructions described herein.
Do not employ accessories other than those specified herein; otherwise, a hazardous condition may be created.
Never allow a power tool to be used by persons not familiar with correct handling (such as children) or by those who cannot handle the tool correctly.
22. **CONFIRM THAT NO ITEMS SUCH AS AN ELECTRIC CABLE OR CONDUIT ARE BURIED INSIDE.** In places where live wiring may be hidden behind a wall, floor, ceiling, etc. do not hold or contact any metal parts of the tool. In such cases, metal parts could become electrically live and present a serious shock hazard.

- 23. KEEP THE RIGHT PARTS IN THE RIGHT POSITIONS.** Do not remove covers and screws which have been factory-mounted. They perform important respective roles. Keep them in the right positions.
- 24. SHOULD THE PLASTIC HOUSING OR HANDLE OF A POWER TOOL BE CRACKED OR DEFORMED, DO NOT USE IT.** Since cracked or deformed parts may lead to an operator receiving an electric shock, do not use such a power tool. Immediately have it repaired.
- 25. SECURELY MOUNT ACCESSORIES AND BLADES TO THE TOOL MAIN BODY.** Extra care must be taken when using tools on elevated location (such as a roof ladder, scaffold, or the like) to prevent injury to someone on a lower level in the event the tool and/or accessory should drop.
- 26. ALWAYS KEEP THE MOTOR AIR VENT FULLY OPENED.** A constantly open motor air vent is necessary to allow air to come in and out for cooling the motor. Do not allow it to become clogged up, even if dust is blown through it.
- 27. OPERATE POWER TOOLS AT THE RATED VOLTAGE.** Operate power tools at voltages specified on their nameplates.
- 28. NEVER TOUCH THE MOVING PARTS.** Never touch the moving parts such as blades, bits, cutters and others.
- 29. STOP OPERATION IMMEDIATELY IF ANY ABNORMALITY IS DETECTED.** Should a power tool be detected as out of order or should other abnormalities be observed during operation, stop using the tool immediately.
- 30. NEVER LEAVE TOOL RUNNING UNATTENDED. TURN POWER OFF.** Don't leave tool until it comes to a complete stop.
- 31. CAREFULLY HANDLE POWER TOOLS.** Should a power tool be dropped or struck against hard materials inadvertently, it may be deformed, cracked, or damaged.
- 32. DO NOT WIPE PLASTIC PARTS WITH SOLVENT.** Solvents such as gasoline, thinner, benzene, carbon tetrachloride, and alcohol may damage and crack plastic parts. Do not wipe them with such solvents. Wipe plastic parts with a soft cloth lightly dampened with soapy water.
- 33. WHEN REPLACING A COMPONENT PART, ADOPT THE SAME TYPE.** When replacing a component part with a new one, adopt the same type of new part. Also, never attempt to repair a power tool yourself.

SERVICE AND REPAIRS

All quality tools will eventually require servicing or replacement of parts due to wear from normal use. These operations should **ONLY** be performed by an **AUTHORIZED HITACHI POWER TOOL REPAIR SHOP.**

REPLACEMENT PARTS

When servicing use only identical replacement parts.

POLARIZED PLUGS

To reduce the risk of electric shock, this equipment has a polarized plug (one blade is wider than the other).

This plug will fit in a polarized outlet only one way.
 If the plug does not fit fully in the outlet, reverse the plug.
 If it still does not fit, contact a qualified electrician to install the proper outlet.
 Do not change the plug in any way.

EXTENSION CORD

Make sure your extension cord is in good condition. When using an extension cord, be sure to use one heavy enough to carry the current your product will draw. An undersized cord will cause a drop in line voltage resulting in loss of power and overheating. Table shows the correct size to use depending on cord length and nameplate ampere rating. If in doubt, use the next heavier gage. The smaller the gage number, the heavier the cord.

MINIMUM GAGE FOR CORD SETS

		Total Length of Cord in Feet (Meter)			
		0-25 (0-7.6)	26-50 (7.9-15.2)	51-100 (15.5-30.5)	101-150 (30.8-45.7)
Ampere More Than	Rating Not More Than	AWG			
	0-6	18	16	16	14
	6-10	18	16	14	12
	10-12	16	16	14	12
	12-16	14	12	Not Recommended	

DOUBLE INSULATION SYSTEM ENHANCES SAFE OPERATION

To enhance safe operation of this electric power tool, HITACHI has adopted a double insulation system. The term “double insulation” used here denotes an insulation system with two insulations physically separated and arranged between the electrically conductive material connected to the power supply and the outer frame subject to contact by the operator.



DOUBLE INSULATION

Thus, the power tool is termed double insulated and both the “” mark and “Double insulation”, or either one is indicated on the name plate.

While no external grounding is required with this system, normal safety precautions as outlined in this manual must still be followed.

To maintain the effectiveness of the double insulation system, follow the precautions described below:

1. Always contact your dealer or an authorized HITACHI power tool repair shop when assembling, disassembling or replacing parts other than accessories or carbon brushes. Improper assembly and/or replacement with wrong parts may result in eliminating the double insulation-feature.
2. Clean the exterior of the tool with a soft cloth moistened with soapy water, and dry thoroughly. Chloric solvent, gasoline, and thinner will cause plastic components to dissolve.

SAVE THESE INSTRUCTIONS.

NANE OF PARTS

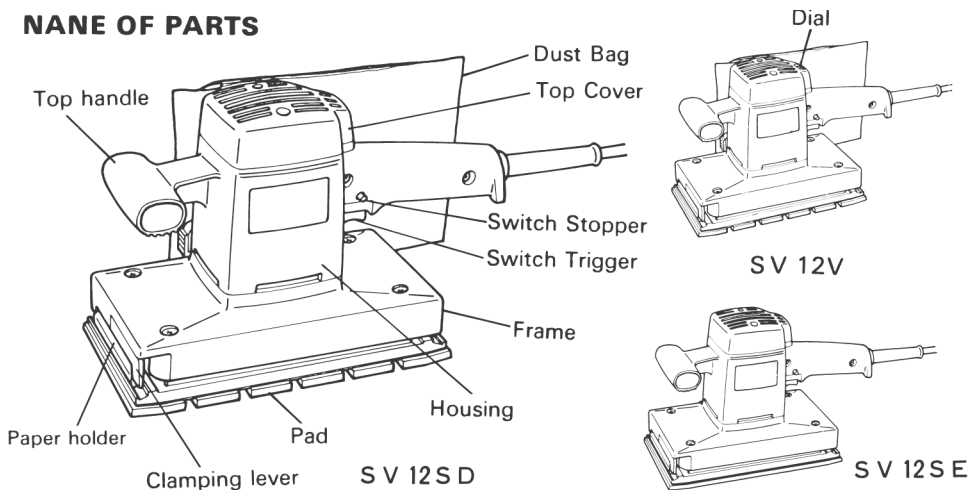

Fig. 1

Model	SV12V	SV12SD	SV12SE
Motor	Single-Phase. Series Commutator Motor.		
Power Source	Single-Phase 115V AC 60Hz		
Rated Current	2.8A		
No-Load Speed	4,000-10,000rpm	10,000rpm	
Dia. of Orbit	3/32" (2.4mm)		
Sanding Pad Size	4-1/2"×9" (114mm×228mm)		
Sanding Paper Size	4-1/2"×11" (114mm×280mm)		
Weight	6.2lbs. (2.8kg)		5.7lbs. (2.6kg)
Remarks	with electronic control system and dust collector	with dust collector	without dust collector

ACCESSORIES

CAUTION:

Recommended accessories for this electric power tool are mentioned in this manual. The use of any other attachment or accessory might be hazardous.

STANDARD ACCESSORIES

- (1) Sanding paper 1
- (2) Dust Bag(for Model SV12V, SV12SD, Code No. 300177) 1

Standard accessories are subject to change without notice.

OPTIONAL ACCESSORIES (sold separately)

- Sanding paper(10 sheets per package)

Type		Grit. No.	Remarks
Standard Type	Perforated	AA40, AA60	for Model SV12V,SV12SD
	non-Perforated	AA80, AA100	for Model SV12SE
Pressure Sensitive Type	Perforated	AA120, AA150	for Model SV12V,SV12SD
	non-Perforated	AA180,AA220 AA240	for Model SV12SE

- Magic Pad(Pressure Sensitive Type) (4-1/2"×9" (114mm×228mm))
 - Perforated Pad(for Model SV12V, SV12SD, Code No. 300081)
 - non-Perforated Pad(for Model SV12SE, Code No. 300083)
 - Cleaner Adaptor(for Model SV12V, SV12SD, Code No. 300082)
- Optional accessories are subject to change without notice.

APPLICATIONS

- Finish polishing of woodwork surfaces.
- Sanding surfaces of woodwork or sheet metal prior to painting, etc.

PRIOR TO OPERATION

1. Power Source

Ensure that the power source to be utilized conforms to the power requirements specified on the product nameplate.

2. Power Switch

Ensure that the power switch is in the OFF position. If the plug is connected to a power receptacle while the power switch is in the ON position, the power tool will start operating immediately, inviting serious accident.

3. Extension cord

When the work area is removed from the power source, use an extension cord of sufficient thickness and rated capacity. The extension cord should be kept as short as practicable.

4. Attaching the sanding paper(start at switch handle's side)

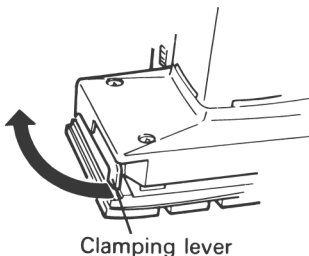

Fig. 2

- (1) Open paper holder by turning clamping lever.(Fig. 2)
- (2) Place the sander as shown in Fig. 3. Insert the sanding paper between the paper holder and the bottom plate until it can go on further.
- (3) Match the width of the sanding paper with the width of the pad. Return the clamping lever to it original position to secure the sanding paper.

(4)-1 When using perforated sanding paper.

To secure the other end of the sanding paper, pull the sanding paper while aligning the holes of the sanding paper with the holes of the pad.

(4)-2 When using non-perforated sanding paper.

To secure the other end of the sanding paper, pull the sanding paper while aligning the sanding paper on the pad.

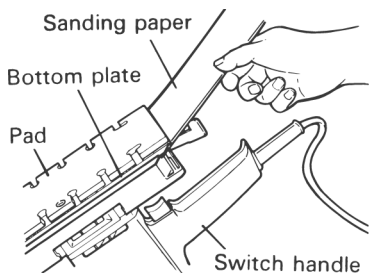

Fig. 3

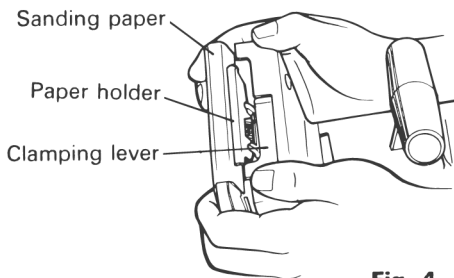

Fig. 4

CAUTIONS

- (1) After mounting the sanding paper, be sure to return the clamping lever to its original position.
- (2) The sanding paper must be precisely attached on the pad. Also ascertain that the sanding paper is attached with ample tension (leaving no slack); otherwise, unevenly sanded surfaces or damage to the actual sanding paper may result. (Figs. 5 and 6)

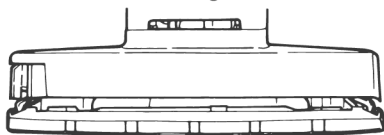

Fig. 5

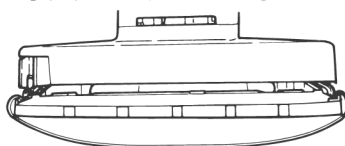

Fig. 6

5. Installing and removing the dust bag. (for model SV12V, SV12SD)

(1) Installation

As shown in Fig. 7 hold the dust gate and push in the dust bag into the frame's dust bag holder.

(2) Removal

As shown in Fig. 8, push the dust gate's tab hard and remove the dust bag from the frame.

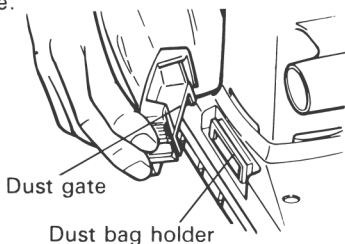

Fig. 7

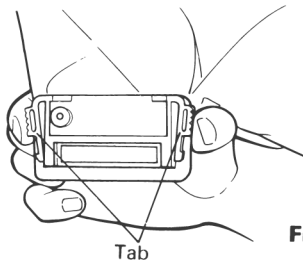

Fig. 8

PRACTICAL OPERATING PROCEDURES

CAUTION:

Never apply water or grinding fluid when sanding. This could result in electrical shock.

1. Switching the sander ON and OFF

By pulling the trigger and pushing the stopper, the switch will remain ON even when the trigger is released, promoting continuous, efficient operation. By pulling the trigger again, the stopper is released and the switch is turned OFF.

CAUTION:

Never turn the power switch ON when the sander is contacting the surface to be sanded. This is necessary to preclude damage to the workpiece. The same applies when switching the power OFF.

2. How to hold the Orbital Sander

While gripping the Top handle with one hand and the handle with the other, lightly press the sander against the surface to be sanded so that the sanding paper uniformly contacts the surface, as shown in Fig. 9. DO NOT apply excessive pressure to the sander while sanding. Excessive pressure may cause overload of the motor, reduced service life of the sanding paper, and lower sanding or polishing efficiency. Also, while sanding or polishing, never cover the ventilation port on the upper motor housing. This could cause overheating and subsequent damage to the tool.

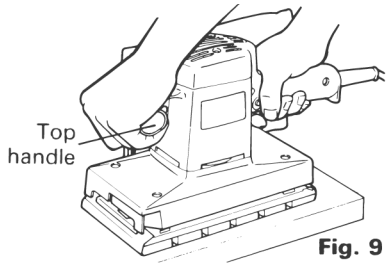

Fig. 9

3. How to move the Orbital Sander

For optimum operating efficiency, alternately move the sander forward and backward at constant speed and balance.

4. Changing the rotating Speed (Model SV12V only)

SV12V has an electronic control system which can be used to set the rotating speed between 4000 and 10,000 per minute. As shown in Fig. 10, dial position "1" is for minimum speed and position "5" for maximum speed.

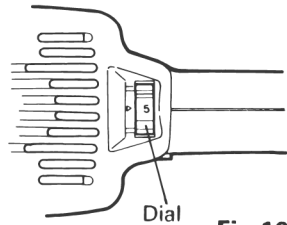

Fig. 10

MOUNTING THE OPTIONAL ACCESSORIES

CAUTION:

Be sure to switch power OFF and disconnect the attachment plug from the power receptacle to avoid serious trouble.

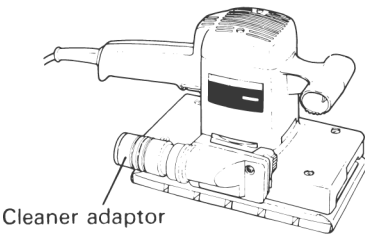

Fig. 11

1. Mounting the magic pad.

Loosen the six screws. Remove the pad and attach the magic pad.

CAUTION:

Replace the pad only. Use the other parts without removing them.

2. Mounting the cleaner adaptor (for model SV12V, SV12SD)

After mounting the dust collector hose onto the cleaner adaptor, mount the cleaner adaptor onto the unit in the same way as mounting the dust bag.

MAINTENANCE AND INSPECTION

CAUTION:

Be sure to disconnect the plug during maintenance and inspection.

1. Emptying and cleaning the Dust bag (for Model SV12V, SV12SD)

If the dust bag contains too much saw dust, dust collection will be affected. Empty the dust bag before it gets full. Remove the dust bag, open the fastener, and dispose of the contents.

2. Inspecting the sanding paper

Since use of worn-out sanding paper will degrade efficiency and cause possible damage to the pad, replace the sanding paper as soon as excessive abrasion is noted.

3. Inspecting the mounting screws

Regularly inspect all mounting screws and ensure that they are properly tightened. Should any of the screws be loose, retighten them immediately. Failure to do so could result in serious hazard.

4. Inspecting the carbon brushes(Fig. 12)

The motor employs carbon brushes which are consumable parts. Since an excessively worn carbon brush could result in motor trouble, replace the carbon brush with a new one which has the same brush No. shown in the figure when it becomes worn to or near the "wear limit". In addition, always keep carbon brushes clean and ensure that they slide freely within the brush holders.

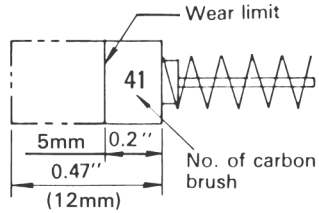

Fig. 12

5. Replacing a carbon brush(Fig. 13)

○ Disassembling:

- (1) Loosen the two screws on the top cover, and remove the top cover.
- (2) Lift out the brush holder together with the carbon brush, while being very careful not to forcibly pull the internal wires within the brush holder.
- (3) Withdraw the brush terminal, and remove the carbon brush from the brush holder.

○ Reassembling:

- (1) Insert the brush terminal into the brush holder. Turn the brush terminal 90° (Fig. 14.)
- (2) While maintaining this brush terminal position as explained in (1), insert a new carbon brush into the brush holder.
- (3) While pressing the carbon brush against the outside wall of the housing's bearing compartment, insert the brush holder into the housing's original position.
- (4) Place the internal wire in the specified position. Be very careful not to allow the internal wire to contact the armature or rotating parts of the motor.
- (5) Replace the top cover, while being careful to ensure it does not pinch the internal wire, and secure it firmly with the two screws.

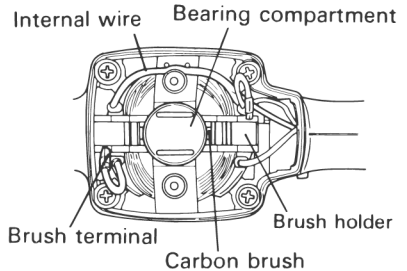

Fig. 13

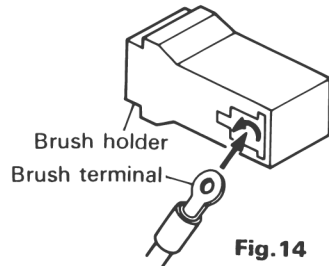

Fig. 14

CAUTION:

Should the internal wire be pinched by the top cover or come in contact with the armature or rotating parts of the motor, a serious danger of electric shock to the operator will be created. Exercise extreme caution in disassembling and reassembling the motor, following the above procedures exactly.

DO NOT attempt to disassemble any parts other than those necessary to effect replacement of the carbon brush.

6. Maintenance of the motor

The motor unit winding is the very "heart" of the power tool. Exercise due care to ensure the winding does not become damaged and/or wet with oil or water.

NOTE:

Due to HITACHI's continuing program of research and development, the specifications herein are subject to change without prior notice.

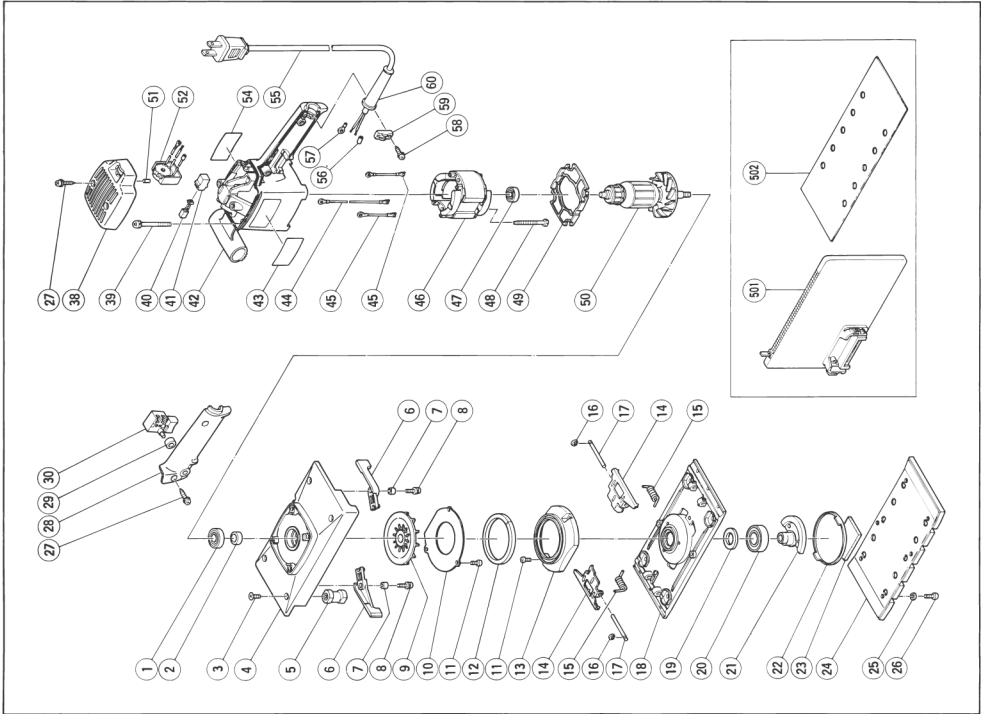

Item No.	Part Name
1	Ball Bearing (6001DDCM)
2	Sleeve
3	Flat Hd. Screw M5 x 14
4	Frame
5	Rubber Leg
6	Lever
7	Distance Piece
8	Machine Screw M4 x 16
9	Fan
10	Dust Fan Guide
11	Machine Screw M4 x 10
12	Felt (A)
13	Dust Guide
14	Paper Holder
15	Spring
16	E-Type Retaining Ring
17	Holder Bar
18	Bottom Plate
19	Felt
20	Ball Bearing (6203DDDCM)
21	Balance Weight
22	Cover Ass'y
23	Support (B)
24	Pad (Perforated)
25	Spring Lock Washer
26	Machine Screw M5 x 14
27	Tapping Screw D4 x 20
28	Handle Cover
29	Pushing Holder
30	Switch
34	Connector

Item No.	Part Name
38	Top Cover
39	Machine Screw (+-Hd.) M5 x 60
40	Carbon Brush
41	Brush Holder
42	Housing
43	HITACHI Label
44	Internal Wire
45	Internal Wire
46	Stator
47	Ball Bearing (608VVC2)
48	Hexagon Hd. Topping Screw D5 x 55
49	Fan Guide
50	Armature
51	Bearing Lock
52	Speed Controller
54	Name Plate
55	Cord
56	Tube (D)
57	Terminal
58	Tapping Screw D4 x 16
59	Cord Crip
60	Cord Armor
501	Dust Bag
502	Sanding Paper (Perforated) 11.4 x 280 AA80

Parts are subject to possible modification without notice due to improvements.

WARNING:

Some dust created by power sanding, sawing, grinding, drilling, and other construction activities contains chemicals known to the State of California to cause cancer, birth defects or other reproductive harm. Some examples of these chemicals are:

- Lead from lead-based paints,
- Crystalline silica from bricks and cement and other masonry products, and
- Arsenic and chromium from chemically-treated lumber.

Your risk from these exposures varies, depending on how often you do this type of work. To reduce your exposure to these chemicals: work in a well ventilated area, and work with approved safety equipment, such as those dust masks that are specially designed to filter out microscopic particles.

Issued by

 **Hitachi Koki Co., Ltd.**

Shinagawa Intercity Tower A, 15-1, Konan 2-chome,
Minato-ku, Tokyo 108-6020, Japan

Distributed by

 **Hitachi Koki U.S.A., Ltd.**

3950 Steve Reynolds Blvd.
Norcross, GA 30093

 **Hitachi Koki Canada Co.**

6395 Kestrel Road
Mississauga ON L5T 1Z5

305

Code No. C99016963 N

Printed in Japan