

WARNING:

Some dust created by power sanding, sawing, grinding, drilling, and other construction activities contains chemicals known to the State of California to cause cancer, birth defects or other reproductive harm. Some examples of these chemicals are:

- Lead from lead-based paints,
- Crystalline silica from bricks and cement and other masonry products, and
- Arsenic and chromium from chemically-treated lumber.

Your risk from these exposures varies, depending on how often you do this type of work. To reduce your exposure to these chemicals: work in a well ventilated area, and work with approved safety equipment, such as those dust masks that are specially designed to filter out microscopic particles.

AVERTISSEMENT:

La poussière résultant d'un ponçage, d'un sciage, d'un meulage, d'un perçage ou de toute autre activité de construction renferme des produits chimiques qui sont connus par l'État de Californie pour causer des cancers, des malformations congénitales et autres anomalies de reproduction. Nous énumérons ci-dessus certains de ces produits chimiques :

- Plomb des peintures à base de plomb,
- Silice cristalline des briques et du ciment et autres matériaux de maçonnerie, et
- Arsenic et chrome du bois d'œuvre traité chimiquement.

Le risque d'exposition à ces substances varie en fonction de la fréquence d'exécution de ce genre de travail. Pour réduire l'exposition à ces produits chimiques, travailler dans un lieu bien ventilé, et porter un équipement de protection agréé, par exemple un masque anti-poussière spécialement conçu pour filtrer les particules microscopiques.

ADVERTENCIA:

Algunos polvos creados por el lijado mecánico, el aserrado, el esmerilado, el taladrado y otras actividades de construcción contienen sustancias químicas consideradas por el Estado de California como cancerígenas, causantes de defectos en el feto y otros daños reproductivos. Algunos ejemplos de estas sustancias químicas son:

- El plomo de las pinturas a base de plomo,
- El sílice cristalino de los ladrillos y cemento y otros productos de mampostería, y
- El arsénico y el cromo de la madera tratada químicamente.

El riesgo resultante de la exposición varía según la frecuencia con que se realiza este tipo de trabajo. Para reducir la exposición a estas sustancias químicas: trabaje en un lugar bien ventilado y realice el trabajo utilizando el equipamiento apropiado, tal como las máscaras para el polvo especialmente diseñadas para eliminar las partículas minúsculas.

Issued by

Hitachi Koki Co., Ltd.

Shinagawa Intercity Tower A, 15-1, Konan 2-chome,
Minato-ku, Tokyo 108-6020, Japan

Distributed by

Hitachi Koki U.S.A., Ltd.

3950 Steve Reynolds Blvd.
Norcross, GA 30093

Hitachi Koki Canada Corp.

450 Export Blvd. Unit B,
Mississauga ON L5S 2A4

301

Code No. E99252861 NA
Printed in China

Tanaka

Designed for operating in USA & Canada only.
When this product is used in areas other than the USA & Canada,
we cannot guarantee the product quality and performance.

Model	TCH 22EAP2 (50ST)/TCH 22EBP2 (62ST)	Hedge Trimmer
Modèle	TCH 22ECP2 (62ST)/TCH 22ECP2 (78ST)	Taille-Haies
Modelo		Cortasetos

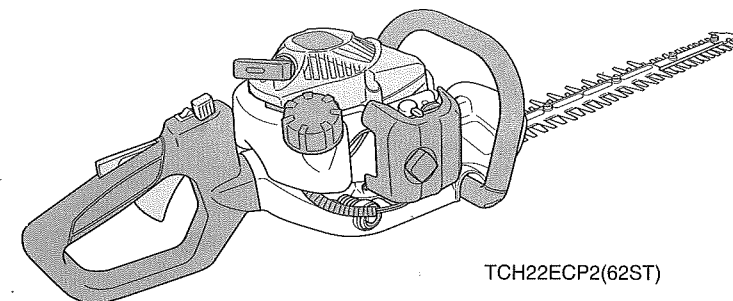

TCH22ECP2(62ST)



SAFETY INSTRUCTIONS AND INSTRUCTION MANUAL

⚠ WARNING

IMPROPER OR UNSAFE use of this power tool can result in death or serious bodily injury!
This manual contains important information about product safety. Please read and understand this manual **BEFORE** operating the power tool. Please keep this manual available for other users and owners before they use the power tool. This manual should be stored in safe place.

INSTRUCTIONS DE SECURITE ET MODE D'EMPLOI

⚠ AVERTISSEMENT

Une utilisation **INCORRECTE OU DANGEREUSE** de cet outil motorisé peut entraîner la mort ou de sérieuses blessures corporelles !
Ce mode d'emploi contient d'importantes informations à propos de la sécurité de ce produit. Prière de lire et de comprendre ce mode d'emploi **AVANT** d'utiliser l'outil motorisé. Garder ce mode d'emploi à la disponibilité des autres utilisateurs et propriétaires avant qu'ils utilisent l'outil motorisé. Ce mode d'emploi doit être conservé dans un endroit sûr.

INSTRUCCIONES DE SEGURIDAD Y MANUAL DE INSTRUCCIONES











⚠ ADVERTENCIA

¡La utilización **INAPROPIADA O PELIGROSA** de esta herramienta eléctrica puede provocar lesiones graves o la muerte!
Este manual contiene información importante sobre la seguridad del producto. Lea y comprenda este manual **ANTES** de utilizar la herramienta eléctrica. Guarde este manual para que puedan leerlo otras personas antes de utilizar la herramienta eléctrica. Este manual debe ser guardado en un lugar seguro.

Hitachi Koki

MEANINGS OF SYMBOLS

NOTE: Some units do not carry them.

Symbols	
<p>⚠ WARNING The following show symbols used for the machine. Be sure that you understand their meaning before use.</p>	
	<p>It is important that you read, fully understand and observe the following safety precautions and warnings. Careless or improper use of the unit may cause serious or fatal injury.</p>
	<p>Read, understand and follow all warnings and instructions in this manual and on the unit.</p>
	<p>Always wear eye, head and ear protectors when using this unit.</p>
	<p>Fuel and oil mixture</p>
	<p>Choke - Run position (Open)</p>
	<p>Choke - Choked position (Closed)</p>
	<p>On/Start</p>
	<p>Off/Stop</p>
	<p>Emergency stop</p>
	<p>Hot surface</p>
<p>Before using your machine</p> <ul style="list-style-type: none"> • Read the manual carefully. • Check that the cutting equipment is correctly assembled and adjusted. • Start the unit and check the carburetor adjustment. See "MAINTENANCE". 	

Contents

WHAT IS WHAT? 3

WARNINGS AND SAFETY INSTRUCTIONS 4

SPECIFICATIONS 6

OPERATING PROCEDURES 6

MAINTENANCE 8

TROUBLESHOOTING 11

WHAT IS WHAT?

Since this manual covers several models, there may be some difference between these illustrations and your unit. Use the instructions that apply to your unit.

1. Recoil starter
2. Fuel tank
3. Throttle lever lockout
4. Throttle lever
5. Front handle
6. Rear handle
7. Spark plug
8. Hand guard
9. Cutting blade
10. Air cleaner
11. Stop switch
12. Blade guide
13. Gear case
14. Choke lever
15. Lock lever
16. Priming pump
17. Blade case
18. Combi box spanner
19. Handling instructions

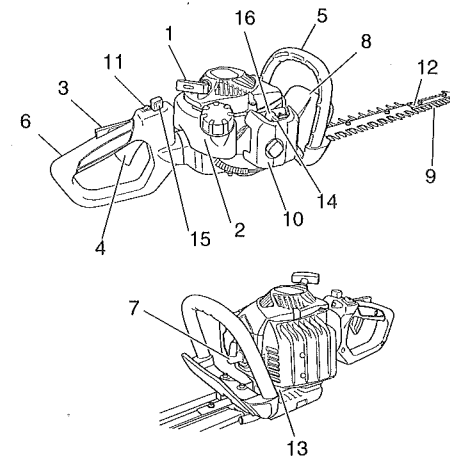

TCH22EAP2 (50ST), TCH22EBP2 (62ST)
TCH22ECP2 (62ST), TCH22ECP2 (78ST)

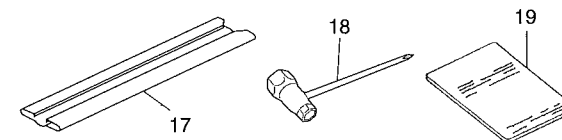

WARNINGS AND SAFETY INSTRUCTIONS

Keep for future reference.

THIS HEDGE TRIMMER CAN CAUSE SERIOUS INJURIES. Read the instructions carefully for the correct handling, preparation, maintenance, starting and stopping of the hedge trimmer. Become familiar with all controls and the proper use of the hedge trimmer.

Operator safety

- Always wear a safety face shield or goggles.
- Always wear heavy, long pants, boots and gloves. Do not wear loose clothing, jewelry, short pants, sandals or go barefoot. Secure hair so it is above shoulder length.
- Do not operate this tool when you are tired, ill or under the influence of alcohol, drugs or medication.
- Never let a child or inexperienced person operate the machine.
- Beware of overhead power lines.
- Wear hearing protection.
- Never start or run the engine inside a closed room or building. Breathing exhaust fumes can kill.
- Keep handles free of oil and fuel.
- Keep hands away from cutting equipment.
- Do not grab or hold the unit by the cutting equipment.
- When the unit is turned off, make sure the cutting attachment has stopped before the unit is set down.
- When operation is prolonged, take a break from time to time so that you may avoid possible Hand-Arm Vibration Syndrome (HAVS) which is caused by vibration.
- If the cutting mechanism strikes any foreign object or the hedge trimmer starts making any unusual noise or vibration, shut off the power source and allow the hedge trimmer to stop. Disconnect the spark plug wire from the spark plug and take the following steps:
 - Inspect for damage;
 - Check for, and tighten, any loose parts;
 - Have any damaged parts replaced or repaired with parts having equivalent specifications.

⚠ WARNING

- **Antivibration systems do not guarantee that you will not sustain Hand-Arm Vibration Syndrome or carpal tunnel syndrome.**

Therefore, continual and regular users should monitor closely the condition of their hands and fingers. If any symptoms of the above appear, seek medical advice immediately.

- **If you are using any medical electric/electronic devices such as a pacemaker, consult your physician as well as the device manufacturer prior to operating any power equipment.**
- **When a foreign object is caught in the blade, turn off the engine, and remove the foreign object carefully using a plier etc., after the hedge trimmer has been cooled down. Be careful when removing the foreign object, since the blade may move because of the backlash.**

Unit/machine safety

- Inspect the entire unit/machine before each use. Replace damaged parts. Check for fuel leaks and make sure all fasteners are in place and securely tightened.
- Replace parts that are cracked, chipped or damaged in any way before using the unit/machine.
- Keep others away when making carburetor adjustments.
- Use only accessories as recommended for this unit/machine by the manufacturer.

⚠ WARNING

Never modify the unit/machine in any way. Do not use your unit/machine for any job except that for which it is intended.

Fuel safety

- Mix and pour fuel outdoors and where there are no sparks or flames.
- Use a container approved for fuel.
- Never remove the fuel cap or add fuel with the power source running. Allow engine and exhaust components to cool down before refuelling.
- Do not smoke or allow smoking near fuel or the unit/machine or while using the unit/machine.
- Never refuel indoors.
- Wipe up all fuel spills before starting engine.
- Move at least 3 m away from fueling site before starting engine.
- Stop engine before removing fuel cap.
- Empty the fuel tank before storing the unit/machine. It is recommended that the fuel be emptied after each use. If fuel is left in the tank, store so fuel will not leak.

- Store unit/machine and fuel in area where fuel vapors cannot reach sparks or open flames from water heaters, electric motors or switches, furnaces, etc.

⚠ WARNING

Fuel is easy to ignite or get explosion or inhale fumes, so that pay special attention when handling or filling fuel.

Cutting safety

- Do not cut any material other than plant hedge.
- Inspect the area to be cut before each use. Remove objects which can be thrown or become entangled.
- For respiratory protection, wear an aerosol protection mask when cutting the grass after insecticide is scattered.
- Keep others including children, animals, bystanders and helpers outside the 15 m hazard zone. Stop the engine immediately if you are approached.
- Hold the unit/machine firmly with both hands.
- Keep firm footing and balance. Do not over-reach.
- Keep all parts of your body away from the muffler and cutting attachment when the engine is running.
- Keep cutting tool below shoulder level. NEVER operate unit from a ladder, while in a tree or from any unstable support.
- When relocating to a new work area, be sure to shut off the machine and ensure that all cutting attachments are stopped.
- Never place the machine on the ground when running.
- Always carry a first-aid kit when operating any power equipment.
- Never start or run the engine inside a closed room or building and/or near the inflammable liquid. Breathing exhaust fumes can kill.

Maintenance safety

- Maintain the unit/machine according to recommended procedures.
- Disconnect the spark plug before performing maintenance except for carburetor adjustments.
- Keep others away when making carburetor adjustments.
- Use only genuine Tanaka replacement parts as recommended by the manufacturer.
- When the hedge trimmer is stopped for servicing, inspection or storage, shut off the power source, disconnect the spark plug wire from the spark plug and make sure all moving parts have come to a stop.

Allow the hedge trimmer to cool before making any inspection, adjustment, etc.

Transport and storage

- Carry the unit/machine by hand with the engine stopped and the muffler away from your body.
- Allow the engine to cool, empty the fuel tank, and secure the unit/machine before storing or transporting in a vehicle.
- Empty the fuel tank before storing the unit/machine. It is recommended that the fuel be emptied after each use. If fuel is left in the tank, store so fuel will not leak.
- Store unit/machine out of the reach of children.
- Clean and maintenance the unit carefully and store it in a dry place.
- Make sure engine switch is off when transporting or storing.
- When transporting in a vehicle or storage, cover blade with blade cover.

If situations occur which are not covered in this manual, take care and use common sense. Contact your Tanaka dealer if you need assistance. Pay special attention to statements preceded by the following words:

⚠ WARNING

Indicates a strong possibility of severe personal injury or loss of life, if instructions are not followed.

⚠ CAUTION

Indicates a possibility of personal injury or equipment damage, if instructions are not followed.

NOTE

Helpful information for correct function and use.

⚠ CAUTION

Do not disassemble the recoil starter. You may get a possibility of personal injury with recoil spring.

SPECIFICATIONS

MODEL	TCH22EAP2 (50ST)	TCH22EBP2 (62ST)	TCH22ECP2 (62ST)	TCH22ECP2 (78ST)
Engine Size (cu. in.)	1.34 (21.1 ml)			
Spark Plug	Champion CJ 6			
Fuel Tank Capacity (fl. oz)	10.1 (0.30 l)			
Dry Weight (lbs)	9.5 (4.3 kg)	10.4 (4.7 kg)	11.0 (5.0 kg)	11.5 (5.2 kg)
Overall blade length (in.)	19.7 (500 mm)	24.4 (620 mm)	24.4 (620 mm)	30.7 (780 mm)
Blade type	Double-sided			
Sound pressure level LpA (dB(A)) (ISO 10517)	84			
Sound power level Lw measured (dB (A)) (2000/14/EC, ISO 10517)	102			
LwA (dB (A))	104			
Vibration level (m/s ²) (ISO 10517)				
Front handle	7.0	9.1	2.8	2.8
Rear handl	7.5	9.1	3.4	2.8

NOTE

Equivalent noise level/vibration level are calculated as the time-weighted energy total for noise/vibration levels under various working conditions with the following time distribution: ISO 10517.....1/5 idle, 4/5 racing. 2000/14/EC.....only racing.

* All data is subject to change without notice.

OPERATING PROCEDURES

Fuel (Fig. 1)

⚠ WARNING

The hedge trimmer is equipped with a two-stroke engine. Always run the engine on fuel, mixed with oil.

Provide good ventilation, when fueling or handling fuel.

Fuel

- Always use branded 89 octane unleaded gasoline.
- Use genuine two-cycle oil or use a mix between 25:1 to 50:1, please consult the oil bottle for the ratio or Tanaka dealer.
- Only for the state of California at 50:1.
- If genuine oil is not available, use an anti-oxidant added quality oil expressly labeled for air-cooled 2-cycle engine use (JASO FC GRADE OIL or ISO EGC GRADE). Do not use BIA or TCW (2-stroke water-cooling type) mixed oil.
- Never use multi-grade oil (10W/30) or waste oil.
- Always mix fuel and oil in a separate clean container.

Always start by filling half the amount of fuel, which is to be used. Then add the whole amount of oil. Mix (shake) the fuel mixture. Add the remaining amount of fuel.

Mix (shake) the fuel-mix thoroughly before filling the fuel tank.

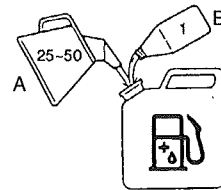

Fig. 1

Fueling

⚠ WARNING (Fig. 2)

- Always shut off the engine before refueling.
- Slowly open the fuel tank (1), when filling up with fuel, so that possible over-pressure disappears.
- Tighten the fuel cap carefully, after fueling.
- Always move the unit at least 10 ft (3 m) from the fueling area before starting.

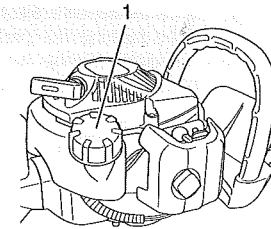

Fig. 2

Before fueling, clean the tank cap area carefully, to ensure that no dirt falls into the tank. Make sure that the fuel is well mixed by shaking the container, before fueling.

Starting

⚠ CAUTION

Before starting, make sure the cutting attachment does not touch anything.

1. Set stop switch (2) to ON position (A). (Fig. 3)

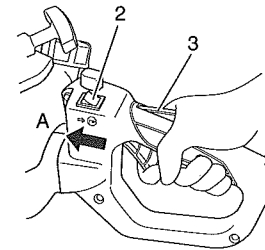

Fig. 3

- * Push priming pump (4) several times so that fuel flows through the pump or return pipe. (Fig. 4)

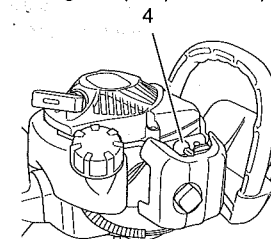

Fig. 4

2. Set choke lever (5) to CLOSED position (B). (Fig. 5)

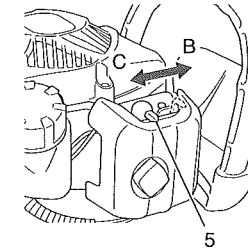

Fig. 5

3. Pull recoil starter briskly, taking care to keep the handle in your grasp and not allowing it to snap back. (Fig. 6)

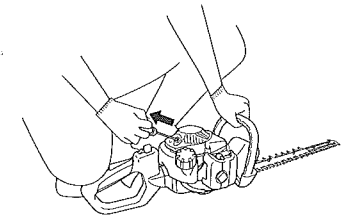

Fig. 6

4. When you hear the engine attempts to start, return choke lever to RUN position (open) (C). Then pull recoil starter briskly again.

NOTE

If engine does not start, repeat procedures from 2 to 3.

5. After starting engine, allow the engine about 2-3 minutes to warm up before subjecting it to any load.

Cutting

When cutting, operate engine at full throttle as this maintains proper blade speed. When trimming top of hedge, hold trimmer so blades are between 15 and 30 degrees from a horizontal position and swing trimmer in an arc toward edge of hedge to sweep cuttings off. When trimming sides of hedge, hold blade vertically and swing unit in an arc.

NOTE

- Multi-position twist handle (Fig. 7)

The rear control handle turns 90 degrees to provide comfortable use while accommodating a variety of cutting angles. The handle allows for five different locking positions. Before attempting to adjust rear handle, make sure the machine is at idle or engine is shut off.

- The throttle lever cannot be engaged if the handle is not secured (the lock lever is pressed). To rotate the handle; push the lock lever (6) allowing the handle to turn. Rotate the handle to the desired 0°, 45° or 90° locking position and release the lock lever (6) to lock the handle in place.

D: LOCK
E: UNLOCK

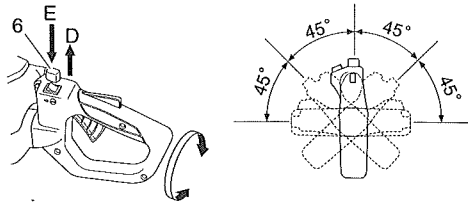

Fig. 7

Stopping (Fig. 8)

Decrease engine speed, and push stop switch to stop position (F).

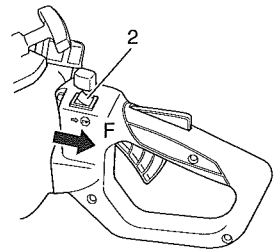

Fig. 8

NOTE

If the engine does not stop, it can be forced to stop by rotating the choke lever to the choked position. Before restarting the engine, ask our dealer for repairs.

MAINTENANCE

MAINTENANCE, REPLACEMENT OR REPAIR OF THE EMISSION CONTROL DEVICES AND SYSTEM MAY BE PERFORMED BY ANY NONROAD ENGINE REPAIR ESTABLISHMENT OR INDIVIDUAL.

Carburetor adjustment (Fig. 9)

⚠ WARNING

- The cutting attachment may be spinning during carburetor adjustments.
- Never start the engine without the complete cleaner cover. Otherwise the clutch can come loose and cause personal injuries.

In the carburetor, fuel is mixed with air. When the engine is test run at the factory, the carburetor is adjusted. A further adjustment may be required, according to climate and altitude. The carburetor has one adjustment possibility:

T = Idle speed adjustment screw.

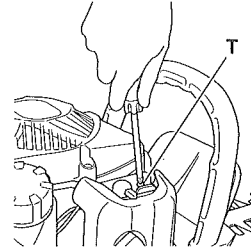

Fig. 9

Idle speed adjustment (T)

Check that the air filter is clean. When the idle speed is correct, the cutting attachment will not rotate. If adjustment is required, close (clockwise) the T-screw, with the engine running, until the cutting attachment starts to rotate. Open (counter-clockwise) the screw until the cutting attachment stops. You have reached the correct idle speed when the engine runs smoothly in all positions well below the rpm when the cutting attachment starts to rotate.

If the cutting attachment still rotates after idle speed adjustment, contact Tanaka dealer.

Air filter (Fig. 10)

The air filter must be cleaned from dust and dirt in order to avoid:

- Carburetor malfunctions.
- Starting problems.
- Engine power reduction.
- Unnecessary wear on the engine parts.
- Abnormal fuel consumption.

Clean the air filter daily or more often if working in exceptionally dusty areas.

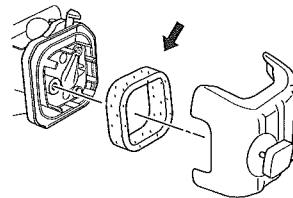

Fig. 10

Cleaning the air filter

Remove the cleaner cover and the filter. Rinse it in warm soap suds. Check that the filter is dry before reassembly. An air filter that has been used for some

time cannot be cleaned completely. Therefore, it must regularly be replaced by a new one. A damaged filter must always be replaced.

NOTE

Saturate the element in 2-cycle oil or the equivalent. Squeeze the element to distribute the oil completely and to remove any excess oil.

Spark plug (Fig. 11)

The spark plug condition is influenced by:

- An incorrect carburetor setting.
- Wrong fuel mixture (too much oil in the gasoline).
- A dirty air filter.
- Hard running conditions (such as cold weather).

These factors cause deposits on the spark plug electrodes, which may result in malfunction and starting difficulties. If the engine is low on power, difficult to start or runs poorly at idling speed, always check the spark plug first. If the spark plug is dirty, clean it and check the electrode gap. Readjust if necessary. The correct gap is 0.024" (0.6 mm). The spark plug should be replaced after about 100 operation hours or earlier if the electrodes are badly eroded.



Fig. 11

NOTE

In some areas, local law requires using a resistor spark plug to suppress ignition signals. If this machine was originally equipped with resistor spark plug, use the same type of spark plug for replacement.

Lubricating the blade (Fig. 12)

During trimming, sap adhering to the blade edge will increase load.

Use machine oil (or bicycle oil or the like) to lubricate the blade and wipe the blade with a cloth. To prevent the blade from rusting, be sure to lubricate the blade after use and when it will not be used for an extended period of time before placing it in the blade case.

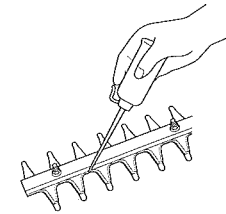

Fig. 12

Gear case (Fig. 13)

Apply a good quality lithium based grease through the grease fitting until a small amount comes out between the cutting blades and the gear case. Lubricate the grease from the grease nipple (indicated by an arrow) next to the gear case using a commercially available cartridge grease gun.

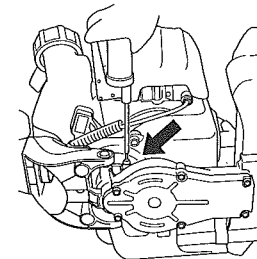

Fig. 13

NOTE

Lubrication should be applied 3g at 20 hour intervals and more frequently with heavy use.

Fuel filter (Fig. 14)

Remove the fuel filter from the fuel tank and thoroughly wash it in solvent. After that, push the filter into the tank completely.

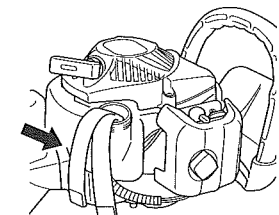

Fig. 14

NOTE

If the filter is hard due to dust and dirt, replace it.

Cleaning the cylinder fins (Fig. 15)

When leaves get caught between cylinder fins (7), the engine may overheat, resulting in lower output. To avoid this, always keep cylinder fins and cylinder cover clean.

Every 100 operating hours, or once a year (more often if conditions require), clean fins and external surfaces of engine of dust, dirt and oil deposits which can contribute to improper cooling.

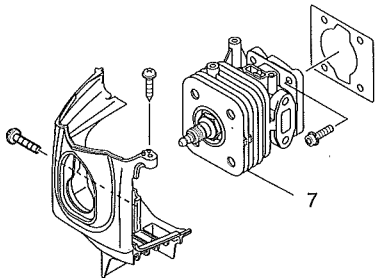

Fig. 15

Cleaning the muffler (Fig. 16)

Remove the muffler and spark arrestor (if so equipped), and clean out any excess carbon from the exhaust port or muffler inlet every 100 hours of operation.

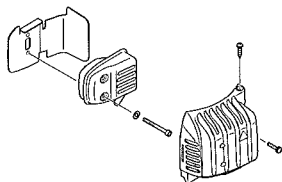

Fig. 16

For long-term storage

Drain all fuel from the fuel tank. Start and let engine run until it stops. Repair any damage which has resulted from use. Clean the unit with a clean rag, or high pressure air hose. Put a few drops of two-cycle engine oil into the cylinder through the spark plug hole, and spin the engine over several times to distribute oil. Cover the unit and store it in a dry area.

Maintenance schedule

Below you will find some general maintenance instructions. For further information please contact your Tanaka dealer.

Daily maintenance

- Clean the exterior of the hedge trimmer.
- Check the blade guide for damage or cracks. Change the guard in case of impacts or cracks.
- Check that the blade is sharp, and without cracks.

- Check that the blade nut is sufficiently tightened.
- Make sure that the blade blunt guard is undamaged and that it can be securely fitted.
- Check that nuts and screws are sufficiently tightened.

Weekly maintenance

- Check the starter, especially cord and return spring.
- Clean the exterior of the spark plug.
- Remove it and check the electrode gap. Adjust it to 0.024" (0.6 mm), or change the spark plug.
- Clean the cooling fins on the cylinder and check that the air intake at the starter is not clogged.
- Check gear case is filled with grease.
- Clean the air filter.

Monthly maintenance

- Rinse the fuel tank with gasoline.
- Clean the exterior of the carburetor and the space around it.
- Clean the fan and the space around it.

TROUBLESHOOTING

Use the inspections in the table below if the tool does not operate normally. If this does not remedy the problem, consult your dealer or the Tanaka dealer.

	Symptom	Possible cause	Remedy
Tool	Does not operate.	Foreign matter is lodged in the blade.	When there is foreign matter in the blade, use a pair of tongs or similar tool to remove it. Take great care since the tool may start operating when the foreign matter has been removed. Sap or rust may also prevent the blade from operating. Use a wire brush or similar tool to remove sap or rust.
	The tool does not trim well.	The blade stopped because it was used to cut a branch whose width exceeded the blade's cutting capacity. NOTE Work that will repeatedly cause the blade to stop will eventually damage the tool.	Some garden trees have wood that is very hard and may be beyond the capacity of the tool even if it is of a width that is within normal capacity. Use a pair of pruning shear to remove thick branches before starting work. An oblique cut may also exceed the capacity of the tool since the length of the cut increases. Be sure to trim thick branches

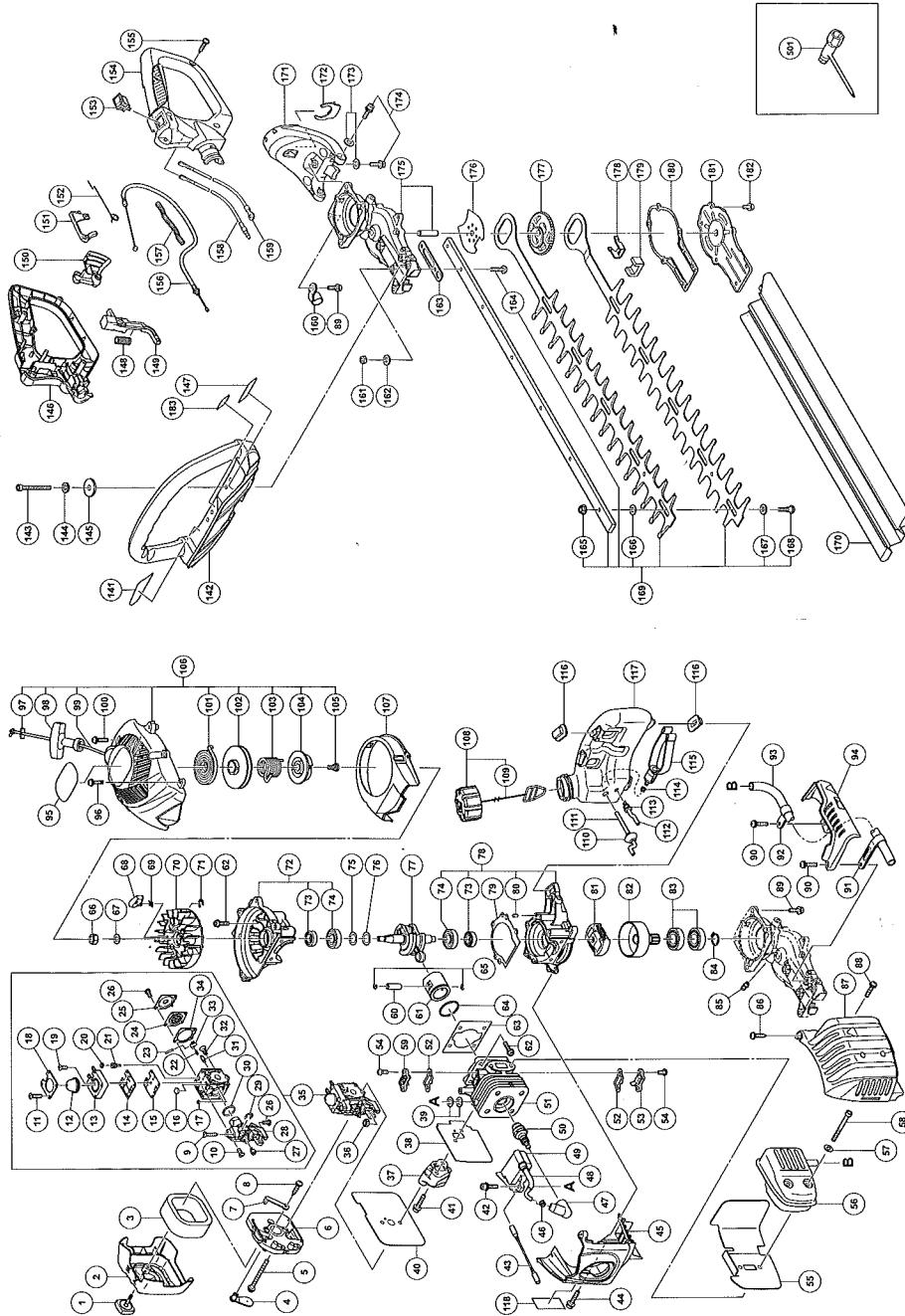

TCH22EAP2 (50ST)

Item No.	Part Name	QTY	Item No.	Part Name	QTY	Item No.	Part Name	QTY
1	COVER FIXING BOLT COMP.	1	58	HEX. SOCKET HD. BOLT M6X55	2	114	CLIP	1
2	CLEANER COVER	1	59	INTAKE COVER (B)	1	115	PUMP FILTER	1
3	CLEANER SPONGE	1	60	PISTON PIN	1	116	CUSHION RUBBER	4
4	CHOKE VALVE	1	61	PISTON	1	117	TANK	1
5	MACHINE SCREW (W/ WASHERS) M5x60	2	62	HEX. SOCKET HD. BOLT (W/SP.WASHER) M5x18	8	118	CAUTION LABEL	1
6	CLEANER BODY	1	63	CYLINDER PACKING	1	141	NAME PLATE	1
7	CHOKE HANDLE	1	64	PISTON RING	1	142	HANDLE	1
8	TAPPING SCREW (W/FLANGE) D4x12	1	65	CIR CLIP	2	143	SEAL LOCK HEX. SOCKET HD. BOLT M5x40	2
9	THROTTLE ADJUST SCREW (TAS)	1	66	FLYWHEEL NUT M7	1	144	SPRING WASHER M5	2
10	SET SCREW (B)	3	67	BOLT WASHER D7	1	145	BRAKE AXIS WASHER	2
11	SET SCREW (D)	4	68	STARTER PAWL	2	146	HANDLE A	1
12	SYRINGE	1	69	STARTER PAWL SPRING	2	147	CAUTION LABEL	1
13	PRIMER BASE	1	70	MAGNETO ROTOR	1	148	SPRING (A)	1
14	PUMP GASKET	1	71	RETAINING RING D4	2	149	LOCK LEVER	1
15	PUMP DIAPHRAGM	1	72	CRANK CASE (B) ASS'Y (INCLUD.73,74)	1	150	THROTTLE LEVER	1
16	STRAINER	1	73	OIL SEAL TB 12227	2	151	TRIGGER LOCKOUT	1
17	GUIDE PIN ROLLER	1	74	BALL BEARING 6001C3	2	152	THROTTLE LEVER SPRING	1
18	SYRINGE RETAINER	1	75	SHIM T0.2	1	153	STOP SWITCH	1
19	SET SCREW (E)	1	76	SHIM T0.3	1	154	HANDLE B	1
20	BALL PLUG RETAINER	1	77	CRANK SHAFT	1	155	TAPPING SCREW (W/FLANGE) D4x16	4
21	ADJUSTING SCREW (MAIN MIXTURE)	1	78	CRANK CASE (A) ASS'Y (INCLUD.73,74,80)	1	156	THROTTLE WIRE	1
22	METERING LEVER SPRING	1	79	CRANK CASE PACKING	1	157	PROTECTION TUBE	1
23	PIN	1	80	KNOCK PIN 4x12	2	158	STOP SWITCH CORD	1
24	METERING DIAPHRAGM	1	81	CLUTCH ASS'Y (B)	1	159	STOP SWITCH CORD (B)	1
25	METERING COVER	1	82	CLUTCH DRUM	1	160	FIXATION PLATE (B)	1
26	SET SCREW (C)	3	83	BALL BEARING 6002ZC3	2	161	NYLON NUT M5	2
27	POST	1	84	RETAINING RING FOR D15 SHAFT	1	162	SMALL WASHER 5	2
28	ROTOR COVER	1	85	GREASE NIPPLE COMP.	1	163	SPACER	1
29	RETAINING RING (E-TYPE) FOR D2.5 SHAFT	1	86	TAPPING SCREW (W/FLANGE) D5x20	1	164	HEX. SOCKET HD. BOLT (W/BUTTON) M5x25	2
30	O-RING	1	87	MUFFLER PROTECTOR	1	165	U-NUT M5	5
31	INLET NEEDLE VALVE	1	88	MACHINE SCREW (W/SP.WASHERS) M5x16	1	166	WASHER (B)	5
32	SET SCREW (A)	1	89	HEX. BOLT 6x18/S	4	167	WASHER M7	5
33	METERING LEVER	1	90	HEX. SOCKET HD. BOLT (W/BUTTON) M5x20	2	168	SHOULDER BUTTON BOLT M5x25	5
34	METERING GASKET	1	91	FIXATION PLATE (A)	1	169	BLADE ASS'Y (INCLUD.164-168)	1
35	CARBURETOR ASS'Y (INCLUD.9-34)	1	92	FIXATION PLATE (B)	1	170	BLADE CASE (A)	1
36	LOCK NUT M6	1	93	TAIL PIPE (A)	1	171	HANDLE BRACKET	1
37	CARBURETOR INSULATOR	1	94	EXHAUST COVER	1	172	CLIP	1
38	INTAKE PACKING	1	95	LABEL	1	173	BOLT WASHER D5	3
39	GLASS WASHER	4	96	TAPPING SCREW D4.5x16	1	174	SEAL LOCK HEX. SOCKET BOLT (W/WASHERS) M5x16	3
40	CARBURETOR PACKING	1	97	PLATE	1	175	GEAR CASE (A) ASS'Y (INCLUD.176)	1
41	SEAL LOCK HEX. SOCKET BOLT (W/WASHERS)M5x25	2	98	STARTER KNOB	1	176	GUIDE PLATE (C)	1
42	HEX. SOCKET HD. BOLT (W/WASHERS) M4x18	2	99	STARTER ROPE	1	177	GEAR 2	1
43	CORD	1	100	HEX. SOCKET HD. BOLT (W/BUTTON) M5x20	3	178	GUIDE PLATE (A)	1
44	SEAL LOCK HEX. SOCKET HD. BOLT M4x12	1	101	RECOIL SPRING	1	179	FELT PACKING (A)	1
45	CYLINDER COVER	1	102	STARTER ROPE REEL	1	180	GEAR CASE PACKING	1
46	METAL OF PLUG CAP (60) (B)	1	103	DAMPER SPRING	1	181	GEAR CASE COVER	1
47	PLUG CAP	1	104	CAM PLATE	1	182	HEX. SOCKET HD. BOLT (W/SP.WASHER) M5x12	6
48	CORD INSULATION TUBE	1	105	SET SCREW	1	183	START LABEL (B)	1
49	IGNITION COIL	1	106	RECOIL STARTER ASS'Y (INCLUD.97-99,101-105)	1	501	BOX WRENCH 10/19MM	1
50	SPARK PLUG	1	107	AIR DEFLECTOR	1			
51	CYLINDER	1	108	FUEL TANK CAP ASS'Y (INCLUD.109)	1			
52	COVER PACKING	2	109	TANK CAP CHAIN	1			
53	INTAKE COVER (A)	1	110	FUEL GROMMET	1			
54	SEAL LOCK SCREW M4x10	4	111	FUEL PIPE	1			
55	HEAT PROTECTION PANEL	1	112	FUEL PIPE (PINK)	1			
56	MUFFLER	1	113	RETURN GROMMET	1			
57	BOLT WASHER M6	2						

HITACHI

English Errata

SPECIFICATIONS

	Incorrect	Correct
Sound pressure level LpA (dB(A)) (ISO 10517)	84	97

 **Hitachi Koki Co., Ltd.**